

albris



The intelligent **mapping**
& **inspection** drone



3 reasons to choose albris

- **1 flight, 3 types of imagery**

With the senseFly albris you can switch between capturing high-res still, thermal and video imagery during the same flight, without landing to change cameras. Thanks to the drone's unobstructed field of view and its head's 180° vertical range of motion, you can capture clear, stabilised imagery ahead of, above and below the albris.

- **Advanced situational awareness**

The senseFly albris features five dual-sensor modules, positioned around the drone. These provide the situational awareness required to operate albris close to structures and surfaces, even in confined environments, in order to achieve sub-millimetre image resolutions (without the movement issues caused by zooming in from afar).

- **Choose your flight mode**

The albris offers full flight mode flexibility. Choose the mode that best fits your project: an Autonomous, GPS-guided mapping mission or a live-streaming Interactive ScreenFly flight. Or start in mapping mode and 'go live' on demand.





Main camera
(HD video & high-res still camera)

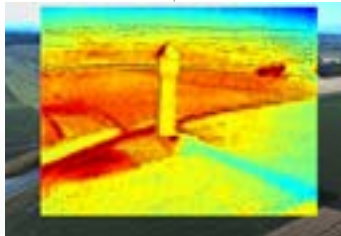

Thermal camera + edge overlay
(video & images)



Head navcam
(wide-angle video camera)

1 flight, 3 types of imagery

The senseFly albris is a sensor-rich platform with the widest camera breadth of any civilian drone. Its fully stabilised TripleView camera head allows you to switch between HD and thermal video imagery, live during

your flight, plus you can capture high-resolution still images on demand. All of this data can be saved for further analysis post-flight, and all without landing to change payloads.

- Main camera (high-res stills/HD video)
- Thermal camera
- Headlamp
- Head navcam
- Ultrasonic receiver
- Ultrasonic transmitter

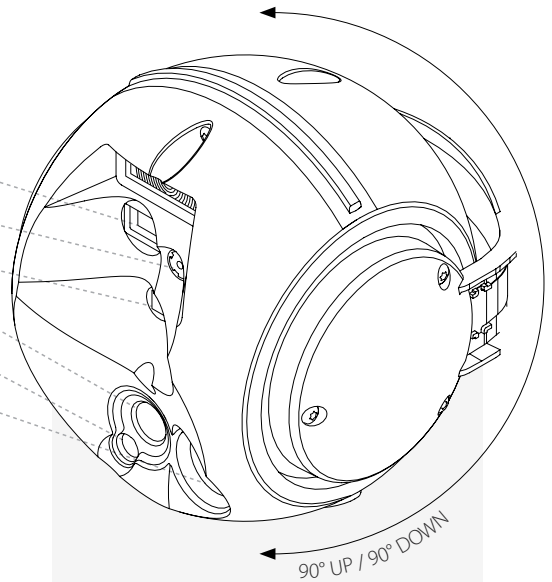

TripleView head

- * 180° vertical range of motion
- * 6x digital zoom
- * Approx. 1 mm still image resolution at 5 m (16.4 ft) distance
- * Active gimbal stabilisation
- * Unobstructed field of view



Advanced situational awareness

The senseFly albris is designed from the ground up to perform live inspections of buildings and other structures. Its onboard navcams and ultrasonic sensors provide the

visual and proximity feedback you require to take the right decisions and maximise every mission's chances of success.

Navcams



Ultrasonic sensors



Head position

Navigate, check for obstacles, keep constant distance from vertical surfaces

Left/Right

Navigate, check for obstacles, see side views

Bottom

Navigate, check for obstacles, land autonomously

Rear

Navigate, check for obstacles, reverse safely

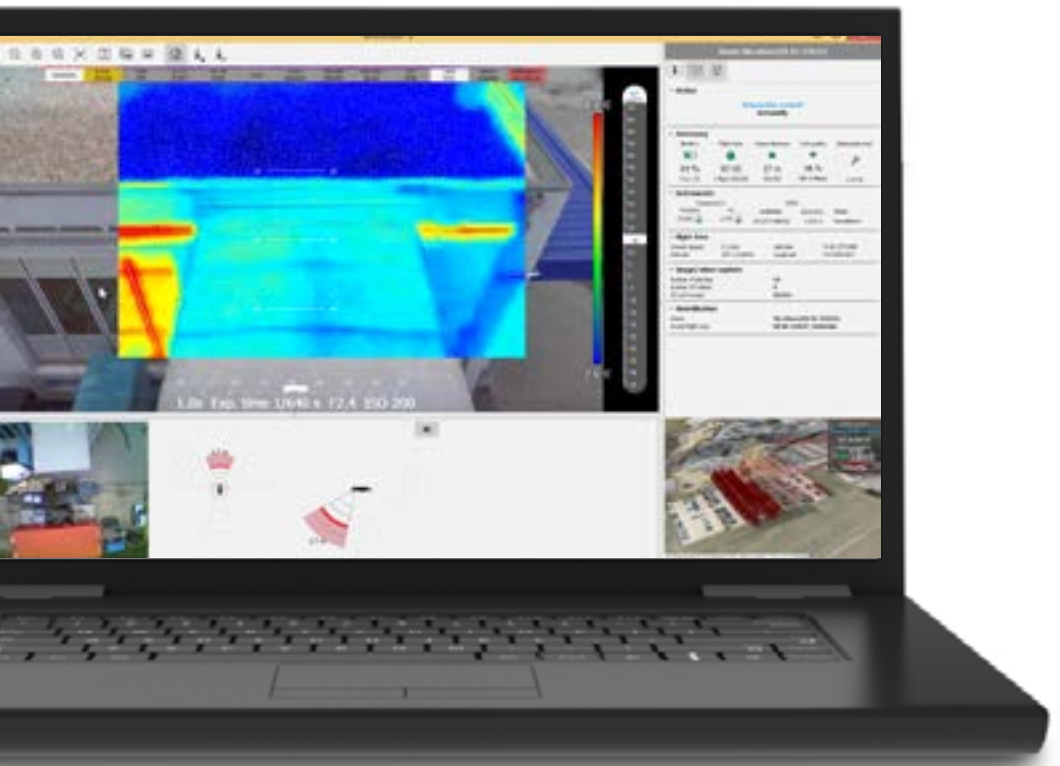

Choose the flight mode that suits your project

Fully autonomous

Are you looking to map a small site, such as a plant or construction site, directly from above? Or maybe a specific point of interest such as a building or tower? If so, choose an autonomous albris mission.

- Specify your area/point of interest in the drone's supplied eMotion 3 software
- eMotion 3 generates a GPS waypoint-based flight plan
- The albris takes off, flies, acquires imagery & lands itself
- View albris' live video stream during flight
- Record imagery on albris' SD card as required for post-flight analysis
- Use image processing software to generate 2D maps & 3D models

Suits: High-res 2D mapping, 3D building mapping, construction monitoring, agricultural & archaeological mapping.

Interactive ScreenFly mode

Need to perform a live inspection? Use the drone's supplied ScreenFly controller to fly an assisted interactive mission.

- Take-off in interactive mode (or switch into this during an autonomous flight)
- 'See what albris sees' on-screen via its multiple live video feeds
- Anti-Drift, Cruise Control & Distance Lock
- Centre albris' cameras on a target
- Capture high-res still images on demand
- GNSS Off option to fly in GNSS-deprived environments

Suits: Structural inspection & documentation, crack/defect detection, solar panel analysis, tower inspection etc.



Live feedback

See what albris sees via its wide-angle navcams

Instant operation

The senseFly albris is ready to fly straight out of its supplied carry case – no construction required

Safety smart

Numerous self-monitoring & automated failsafe procedures reduce the risk of inflight issues, minimising potential danger to structures, people & the albris airframe

Close-object operation

Advanced situational awareness and flight stabilisation are enabled by the drone's:

- 5 ultrasonic sensors
- 5 navcams (visual sensors)

Onboard albris

The senseFly albris is lightweight, shock-absorbent and durable, designed to operate in tight working environments. With its forward-positioned TripleView camera

head and open-fronted airframe it offers an unrivalled field of view, while its propellers are fully protected by its advanced carbon fibre shrouding.



Electric powered
Low noise, no pollution,
and easy battery swapping
for prolonged use

Leading autopilot technology
The artificial intelligence built into
the senseFly autopilot analyses
a raft of data to optimise every
aspect of your flight

Bump-safe construction
The senseFly albris' shock-absorbent
carbon fibre shrouding protects the drone
in case of low-speed surface contact

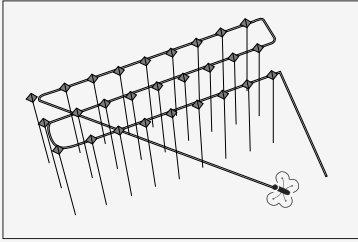

Horizontal Mapping

Use this mission block to fly a 'bird's eye', top-down mapping mission (senseFly eBee style). Just set a few key mission parameters, such as your preferred ground resolution, and eMotion 3 does the rest — creating flight lines and setting GPS waypoints, which are adapted to the terrain, automatically.

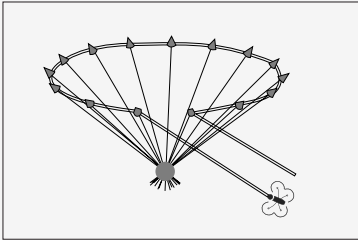

Around Point of Interest

This mission block automatically centres the drone's flight path around a specific point of interest. Once you've set the resolution/distance required, eMotion 3 automatically programs the image capture points. Use this mission block to create a 3D model of an object.

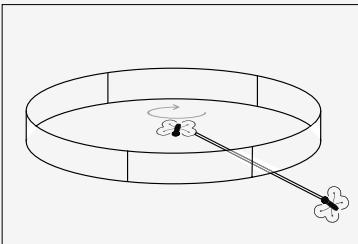

Panorama

This mission block suits a wide range of applications. You could fly a panoramic mission to gain an initial overview of a concave location, such as the curved cliff face of an open pit mine, to give that wow effect to reporting and documentation, to enhance the quality of 3D models... the choice is yours!

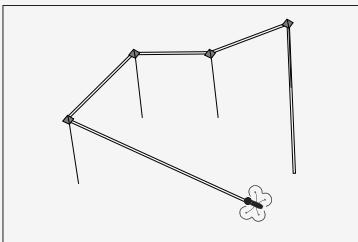

Custom Route

This mission block is perfect for guiding the drone through complex environments. Or if you want to use different types of mission block during a single flight, you can link these together using custom routes.

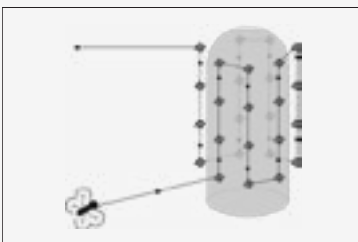

Cylinder

Inspect & digitally model structures such as wind turbines and towers using a senseFly albris. Just set the cylinder's height, its height above ground, plus the image resolution & overlap required. eMotion 3 sets the drone parameters and waypoints required to capture exactly the photos required— in overlapping layers—around the structure.

Intuitive flight planning & feedback



Every senseFly albris is supplied with eMotion 3 software, senseFly's proprietary flight planning, control and feedback program. Developed specifically for albris, eMotion 3 is your flight control centre — featuring live streaming video feedback, full control of what imagery albris captures, access to sensor and flight data, plus full flight planning functionality.

Choose your mission block

Flight planning in eMotion 3 is simple: just select the pre-programmed mission block that best suits your project. Further advanced mission blocks and software updates will be available for free.

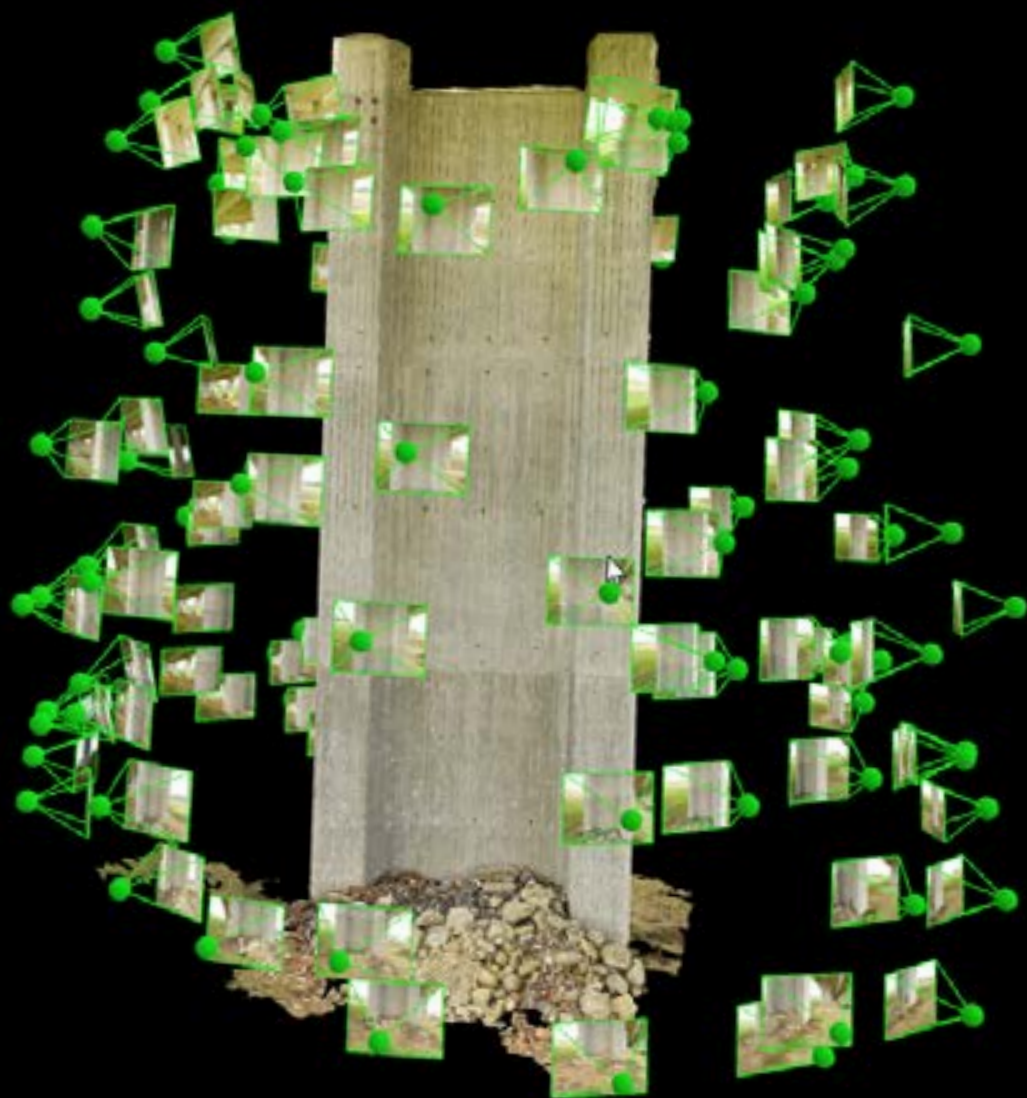

Road bridge pillar inspection, Switzerland

Create geo-referenced maps & models



After albris lands, simply use eMotion 3's built-in Flight Data Manager to pre-process, geotag and organise its images, before starting image processing.

Then use professional image processing software to transform the drone's images into geo-referenced 2D orthomosaics, 3D building models, 3D point clouds, triangle models, digital surface models and more.





High-resolution mapping

Create high-resolution 2D and 3D maps, or complement fixed-wing drone data by mapping a site's highly inclined and vertical surfaces

3D modelling

Capture high-resolution aerial imagery and transform this into full 3D models of buildings and small/medium-sized infrastructure

Inspection

Examine and document surfaces and objects—such as bridges, towers, rooftops and cliff faces—in high-resolution

Plus...

- Crack detection
- Bridge, pipe & tower inspection
- Plant inspection & documentation
- Stockpile assessment
- Construction monitoring
- Close agricultural & archaeological mapping
- Solar panel hotspot detection
- Conservation & environmental monitoring

... and much more

Flight modes

Types	Automatic Interactive ScreenFly Manual (RC)
Availability	Switch between modes at any time

Automatic

Control interface	Mouse, keyboard or touchscreen
Mission planning	Drag-and-drop mission blocks
Types of mission blocks	Horizontal mapping Around point of interest Panorama Custom route
In-flight mission changes	Yes: manual waypoint changes and updates possible at any time

Interactive ScreenFly

Primary control interface	Screen-based actions & USB controller
Flight assistance (depending on the flight phase)	Cruise control Distance lock Range sensing

Manual (RC)

Primary control interface	RC (remote control)
---------------------------	---------------------

On-board computing

Type	4 on-board CPUs
Quad-core processor	Principal autopilot & artificial intelligence
Dual-core processor	Video co-processing
Single-core processor	Low-level autopilot (safety fallback) and motor control
Single-core processor	Communication link management

Flight system

Type	V-shaped quadcopter
Dimensions (incl. shrouding)	56 x 80 x 17 cm (22 x 32 x 7 in)
Engines	4 electric brushless motors
Propellers	4
Take-off weight	1.8 kg (3.9 lb) incl. battery, payload & shrouding
Flight time (full system)	Up to 22 min
Max. climb rate	7 m/s (15 mph)
Max. airspeed	Automatic flight: 8 m/s (18 mph) Manual flight: 12 m/s (27 mph)
Wind resistance	Automatic: up to 8 m/s (18 mph) Manual: up to 10 m/s (22 mph)
Autopilot & control	IMU, magnetometer, barometer & GPS/GNSS
Materials	Composite body, moulded carbon fibre arms and legs, precision-molded magnesium frame, precision-molded injected plastic
Operating temperature	-10 to 40° C (14°-104° F)

Wireless communication

Main communication link

Type	Digital, dual omnidirectional antennas, dual band, encrypted
Frequency	2.4 GHz & 5 GHz ISM bands (country dependent)
Data transmitted	Commands, main camera stream, navcam stream, sensor data, etc.
Range	Up to 2 km (1.2 mi)

RC (Remote control)

Type	Digital
Frequency	2.4 GHz
Range	Up to 800 m (0.5 mi)

System power

Technology	Smart battery
Type	LiPo, 3 cell, 8500 mAh
Power level display	LED display on battery, on-screen information
Charging time	1 - 1.5 h

Integrated payloads

TripleView head

Main camera

Still images	38 MP, mechanical shutter DNG (RAW image with correction metadata) Ground sampling distance (GSD): <ul style="list-style-type: none">- 1 mm/pixel at 6 m- 1 cm/pixel at 60 m Recorded on board Geo-referenced (position & orientation)
Video	HD (1280 x 720 pixels) Recorded on board or streamed
Horizontal field of view	63 degrees
Digital zoom	6x

Thermal camera

Still images/video	Thermal (80 x 60 pixels) overlaid on main camera stream
Horizontal field of view	50 degrees
Edge enhancement	Yes

Head navcam (visual sensor)

Video	VGA (640 x 480 pixels)
Video live streaming range	Up to 2 km (1.24 miles)
Horizontal field of view	100 degrees

Lights

Headlamp	Yes, used for video
Flash	Yes

Additional navcams (visual sensors)

Number	4 navcams
Positions	Left, right, rear, bottom
Video	VGA (640 x 480 pixels)
Horizontal field of view	100 degrees
Availability	One navcam at a time
Operational use	Side views (w/o turning main camera) & parallel flight along objects Back-up safely & control in tight environments Landing & ground proximity

Situational awareness & assistance

Multidirectional video feed

Source	Navcams (visual sensor)
Number	5
Video	VGA (640 x 480 pixels)
Horizontal field of view	100 degrees
Availability	One navcam at a time

Object & range detection

Sensor	Ultrasonic
Number	5
Range	Up to 6 m (20 ft)
Feedback	Audio and visual object warning

Operational safety

Shrouding

Material	Carbon fibre
Function	Defines propeller rotation area Protects from damage at low speed

Signalisation lights

Navigation lights	2 green on the right, 2 red on the left
Anti-collision lights	1 top strobe, 1 bottom strobe

Ground proximity detection

Avoidance procedure	Automatic stop (can be deactivated)
Warning signals	Audio & visual

Flight assistance features (Interactive mode)

Cruise control	Maintains (low) constant speed in a given direction
Distance lock	Keeps distance to frontal objects 3 - 5 m (9.8 - 16 ft)
Obstacle avoidance	Depending on flight phase

Safety procedures

Automated failsafe behaviours	Geofencing, return home, emergency stop, emergency landing
Operator triggered	Hold position, return home, go land, land now, emergency motor cut-off

Autopilot fallback

Type	Independent low-level autopilot (backup for main autopilot)
Manual RC control	Independent RC controller (take manual control at any time)

Ground station software

Software application	senseFly eMotion 3 (supplied)
Mission planning	Intuitive 3D user interface Click and drag to set mission blocks Automatic 3D flight planning Edit mission plans during flight
Flying	Automated system checks Automated take-off & landing Real-time flight status Main camera video feed integration Thermal video feed integration Navcam video feed integration Fully automatic flight Interactive ScreenFly Manual flight (with assistance functions) In-flight switch between flight modes Black-box recording of all flight & mission parameters
After your flight	Project & data management DNG to JPEG conversion

Package contents

- 1 senseFly albris drone
- 1 Interactive ScreenFly controller
- 2.4 GHz remote control (for safety pilots)
- 2.4 GHz/5GHz dual band USB radio modem
- 2 SD memory cards (32 GB)
- 2 batteries
- 2 single battery chargers w/power supplies
- 1 wheeled carry case
- 1 user manual
- 1 USB cable set
- 1 spare leg set
- 1 spare propeller set
- eMotion 3 flight planning & control software





www.sensefly.com

About senseFly: At senseFly, we believe in using technology to make work safer and more efficient. Our proven drone solutions simplify the collection and analysis of geospatial data, allowing professionals in surveying, agriculture, engineering and humanitarian aid to make better decisions, faster.

senseFly was founded in 2009 and quickly became the leader in mapping drones. The company is a commercial drone subsidiary of Parrot Group. For more information, go to www.sensefly.com.

How to order your albris? Visit www.sensefly.com/about/where-to-buy to locate your nearest distributor.

senseFly Ltd
Route de Genève 38
1033 Cheseaux-Lausanne
Switzerland

Content and images non contractual © 2017 senseFly Ltd



www.sensefly.com/albris
Swiss made 



senseFly
a Parrot company

For albris updates
subscribe to our newsletter at
www.sensefly.com

